



5

COMPLEMENTI*

/COMPLEMENTARY ITEMS

SPECCHI, PANCHE E ACCESSORI, AIUTANO A RENDERE PIU' FUNZIONALI ED AL TEMPO STESSO PIU' PERSONALI GLI AMBIENTI DELLA CASA, RISOLVENDO SPAZI ED ESIGENZE DIVERSE. IL LORO DESIGN E LE LORO FINITURE SI ARMONIZZANO CON GLI ALTRI MOBILI, AGGIUNGENDO UN TOCCO IN PIU' ALLO SCENARIO DEL NOSTRO ABITARE.

_EN Mirrors, benches and accessories render spaces more functional and more personal at the same time, resolving different needs and spaces their design and finish is meant to blend with the other furniture, adding an extra touch to our habitat.

_DE Spiegel, bänke und Zubehör tragen dazu bei, die Wohnbereiche funktioneller und gleichzeitig persönlicher zu gestalten, indem Raumlösungen gefunden und unterschiedliche Anforderungen erfüllt werden. Ihr Design und ihre Ausführungen harmonisieren mit den anderen Möbeln und fügen unserem Wohnbereich das gewisse etwas hinzu.

_FR Miroirs, bancs et accessoires permettent de rendre les espaces de la maison plus fonctionnels et plus personnels, en solutionnant les espaces et les diverses problématiques. Leur design et leurs finitions s'harmonisent avec les autres meubles, en ajoutant une touche en plus à notre cadre de vie.

_ES Espejos, bancos y accesorios, ayudan a convertir en más cómodo y al mismo tiempo más personal los ambientes de la casa, solucionando espacios y necesidades diferentes. Su diseño y su acabado se armonizan con otros muebles, añadiendo un toque más al escenario de nuestra casa.



LOGIKA SPECCHI

Logika mirrors
Logika Spiegeln
Logika miroirs
Logika espejos



L. 48 cm
P. 2 cm
H. 96 cm

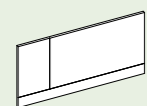

L. 96 cm
P. 2 cm
H. 48 cm



L. 48 cm
P. 2 cm
H. 120 cm

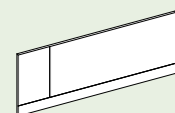

L. 120 cm
P. 2 cm
H. 48 cm



L. 48 cm
P. 2 cm
H. 144 cm

JAZZ SPECCHI

Jazz mirrors
Jazz Spiegeln
Jazz miroirs
Jazz espejos



L. 80 cm
P. 2,5 cm
P. 140 cm

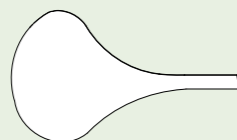

L. 161 cm
P. 2,5 cm
P. 95 cm

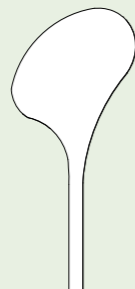

L. 80 cm
P. 2,5 cm
H. 200 cm

SPECCHIERE ROTONDE

Round mirrors
Runde Spiegeln
Miroirs ronds
Espejos redondo



Ø 40 cm
P. 2 cm



Ø 70 cm
P. 2 cm

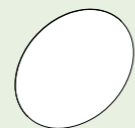

Ø 90 cm
P. 2 cm

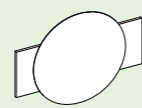

L. 96 cm
P. 2 cm
H. 36 cm

SPECCHIERE SAGOMATE

Shaped mirrors
Geformte Spiegeln
Miroirs façonnés
Espejos perfilado



L. 120 cm
P. 4 cm
H. 48 cm



L. 48 cm
P. 4 cm
H. 120 cm

SPECCHIERE IN CUIOIO

Leather mirrors
Spiegeln Leder
Miroirs en cuir
Espejos cuero

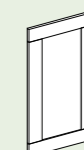

L. 50 cm
P. 2,5 cm
H. 100 cm

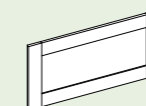

L. 100 cm
P. 2,5 cm
H. 50 cm

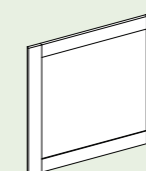

L. 100 cm
P. 2,5 cm
H. 100 cm

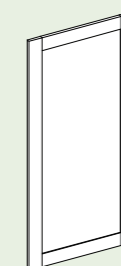

L. 80 cm
P. 2,5 cm
H. 180 cm

**SPECCHIERE CON CORNICE
MELAMINICO/LACCATO**

Mirrors with melamine/lacquered frame
Spiegeln mit Melamin/lackiert Rahmen
Miroirs avec chassis en melaminé/en laqué
Espejos con marco de melamina/lacado



L. 50 cm
P. 8 cm
H. 100 cm

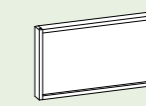

L. 100 cm
P. 8 cm
H. 50 cm

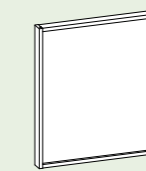

L. 100 cm
P. 8 cm
H. 100 cm



L. 50 cm
P. 8 cm
H. 179 cm



L. 179 cm
P. 8 cm
H. 50 cm



L. 80 cm
P. 8 cm
H. 179 cm

SPECCHIERE TELAIO IN ALLUMINIO BRILLANTE

Mirrors with glossy aluminium frame
 Spiegel mit Aluminium glänzend Rahmen
 Miroirs avec cadre aluminium brillant
 Espejos con marco de aluminio brillo

H.36

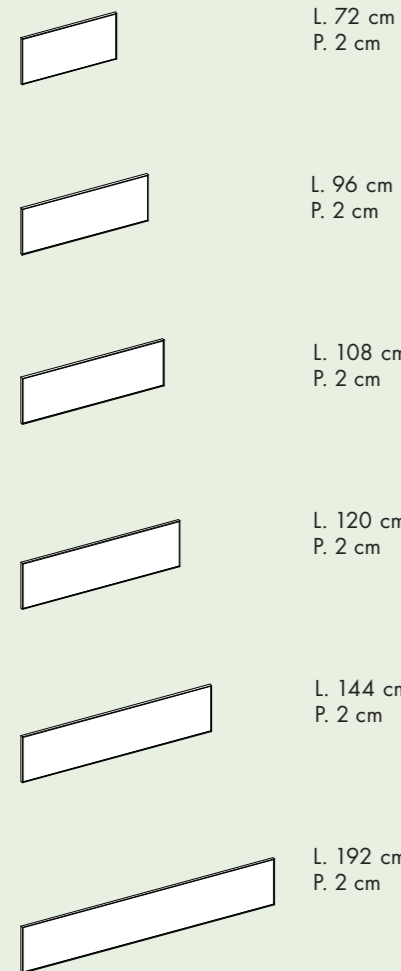

H.48

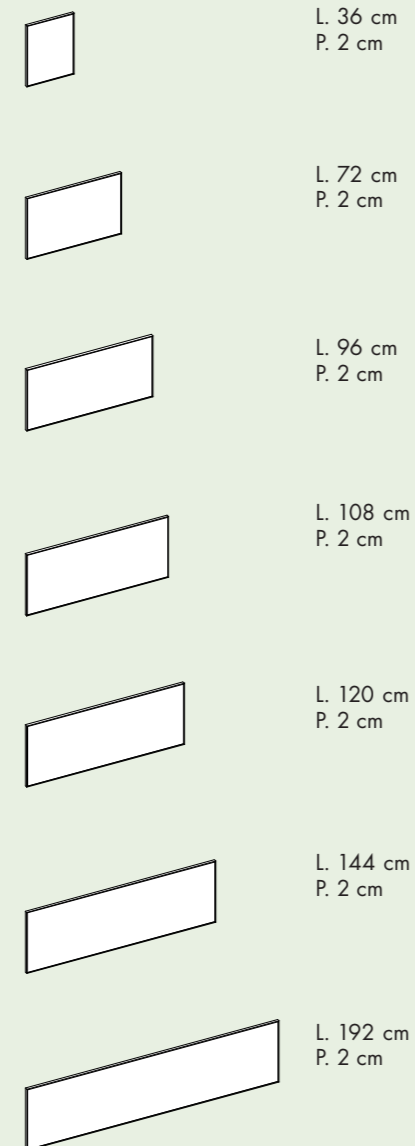

H.72

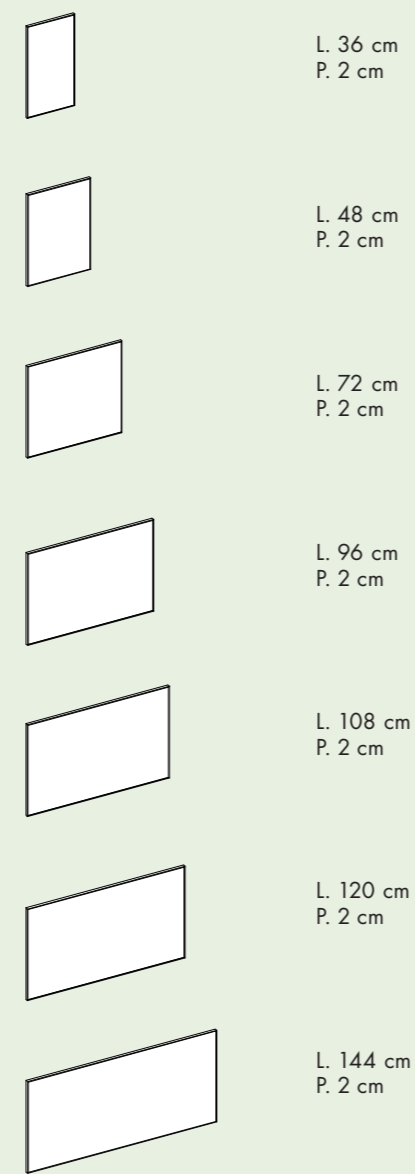

H.96

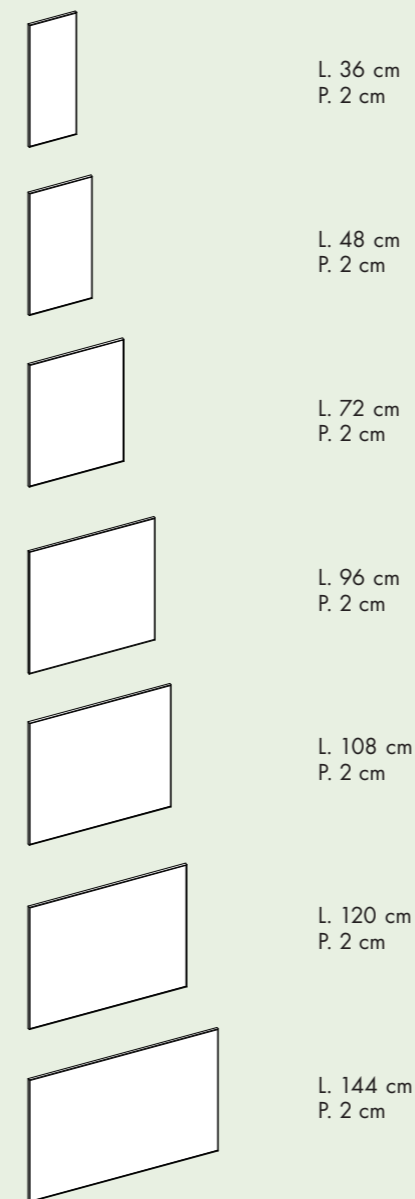

H.108

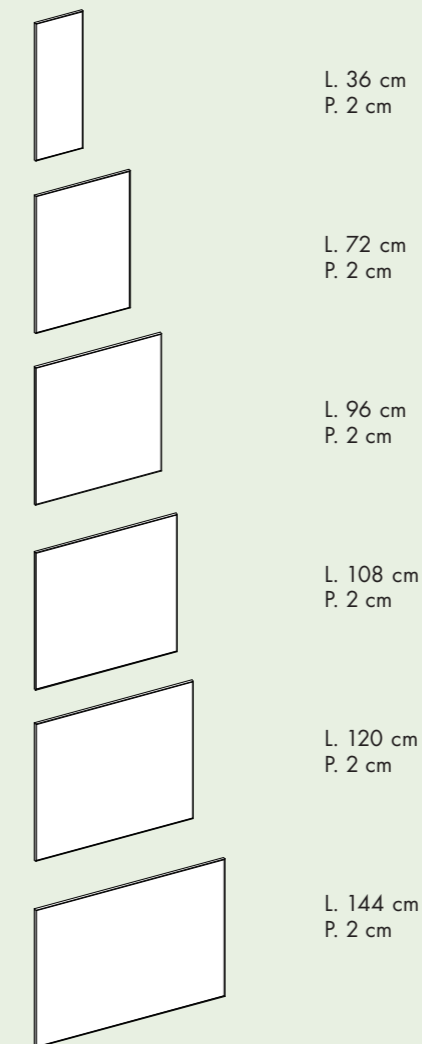

H.192

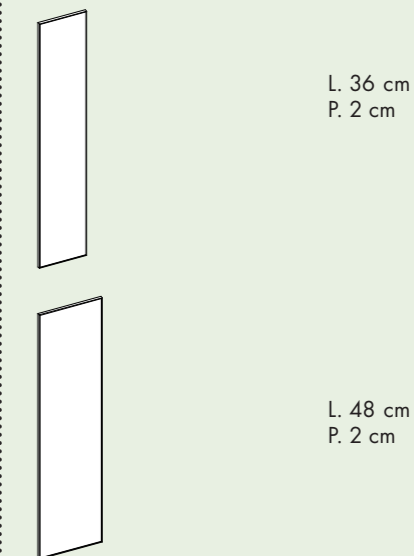

**SPECCHIERE
RETROILLUMINATE**

Black-lighted mirrors
Spiegeln mit Rückbeleuchtung
Miroirs avec illumination arrière
Espejos retro-illuminante

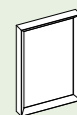

L. 48 cm
P. 8 cm
H. 72 cm

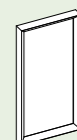

L. 48 cm
P. 8 cm
H. 96 cm

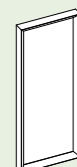

L. 48 cm
P. 8 cm
H. 120 cm

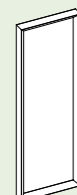

L. 48 cm
P. 8 cm
H. 144 cm

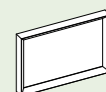

L. 72 cm
P. 8 cm
H. 48 cm

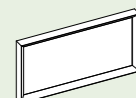

L. 96 cm
P. 8 cm
H. 48 cm

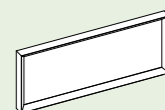

L. 120 cm
P. 8 cm
H. 48 cm

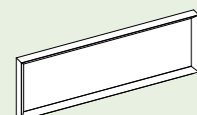

L. 144 cm
P. 8 cm
H. 48 cm

**SPECCHIERE
IN STILE**

Mirrors in style
Spiegelstil
Miroirs en style
Espejos en estilo



L. 78 cm
P. 8 cm
H. 128 cm



L. 90 cm
P. 8 cm
H. 190 cm

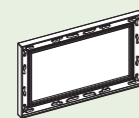

L. 128 cm
P. 8 cm
H. 78 cm

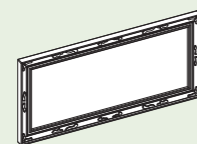

L. 190 cm
P. 8 cm
H. 90 cm



Ø 90 cm
P. 8 cm

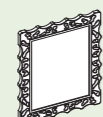

L. 85 cm
P. 8 cm
H. 100 cm

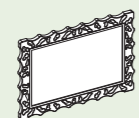

L. 120 cm
P. 8 cm
H. 85 cm

PANCHE

Benches
Bank
Bancs
Bancadas

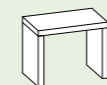

L. 50 cm
P. 30 cm
H. 40 cm

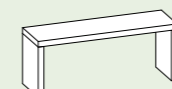

L. 100 cm
P. 30 cm
H. 40 cm

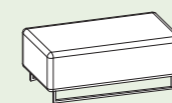

L. 100 cm
P. 40 cm
H. 40 cm

POUF

Pouf
Pouf
Pouf
Pouf



L. 40 cm
P. 40 cm
H. 40 cm

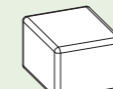

L. 50 cm
P. 40 cm
H. 40 cm



Ø 40 cm
H. 40 cm



Ø 60 cm
H. 40 cm

**APPENDIABITI A COLONNA
BUTTERFLY**

Butterfly coat hanger stand
Turmkleiderhaken Mod. Butterfly
Porte manteau au sol Butterfly
Perchero a columna mod. Butterfly

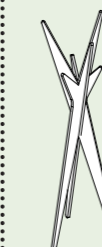

L. 60 cm
P. 60 cm
H. 159 cm

APPENDIABITI FUNGO

Mushroom clothes hangers
Pilzkleiderhaken
Porte-manteau champignon
Perchero hongo



Ø 5/10/15 cm

**APPENDIABITI A COLONNA
IN METALLO VERNICIATO LUCIDO**

Coat hanger stand in glossy varnish metal
Säulen- Kleiderhaken aus glänzend Metall lackiert
Porte manteau à colonne en métal vernie brillant
Perchero a columna en metal lacado brillo



L. 35 cm
P. 35 cm
H. 187 cm

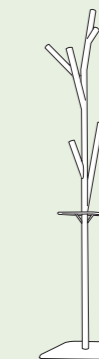

L. 35 cm
P. 35 cm
H. 187 cm

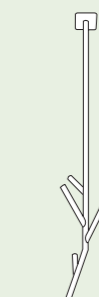

L. 12 cm
P. 12 cm
H. 158 cm



L. 25 cm
P. 25 cm
H. 98 cm

_IT La capienza massima è calcolata su calzature di media grandezza.

_EN Maximum capacity is calculated on the average shoe size.

_DE Die maximale Fassungsvermögen wird auf mittelgroße Schuhe berechnet.

_FR L'occupation maximale est calculée sur la taille moyenne de la chaussure.

_ES La capacidad maxima se calcula con zapatos de medio medida.

art direction

Monica Graffeo

graphics and layout

Genny Canton Studio

photography

Beppe Brancato

Photografica

Studio Auber

Andrea Pancino

styling

Stefano Gaggero

Rosanna Bignucolo

Ciaccia Guarini

copy

Daniele Varelli

print

Grafiche Antiga

thanks to

Mauro Bolognesi

Jannelli&Volpi

Casamania

Ilaria Innocenti

100 Fa

Essent'ial

BIREX

Via Mazzini, 3

33070 Maron di Brugnera (PN) Italy

Tel. +39 0434 565751 r.a.

Fax +39 0434 99151

birex@birex.it

www.birex.it